

# ***Sustainable Hydropower, Water and Energy Security:*** Case studies at Itaipu Binacional- Paraguay



# Circular Economy Ecosystem: Case studies



Image courtesy of Cambridge Judge Business School

Recycling

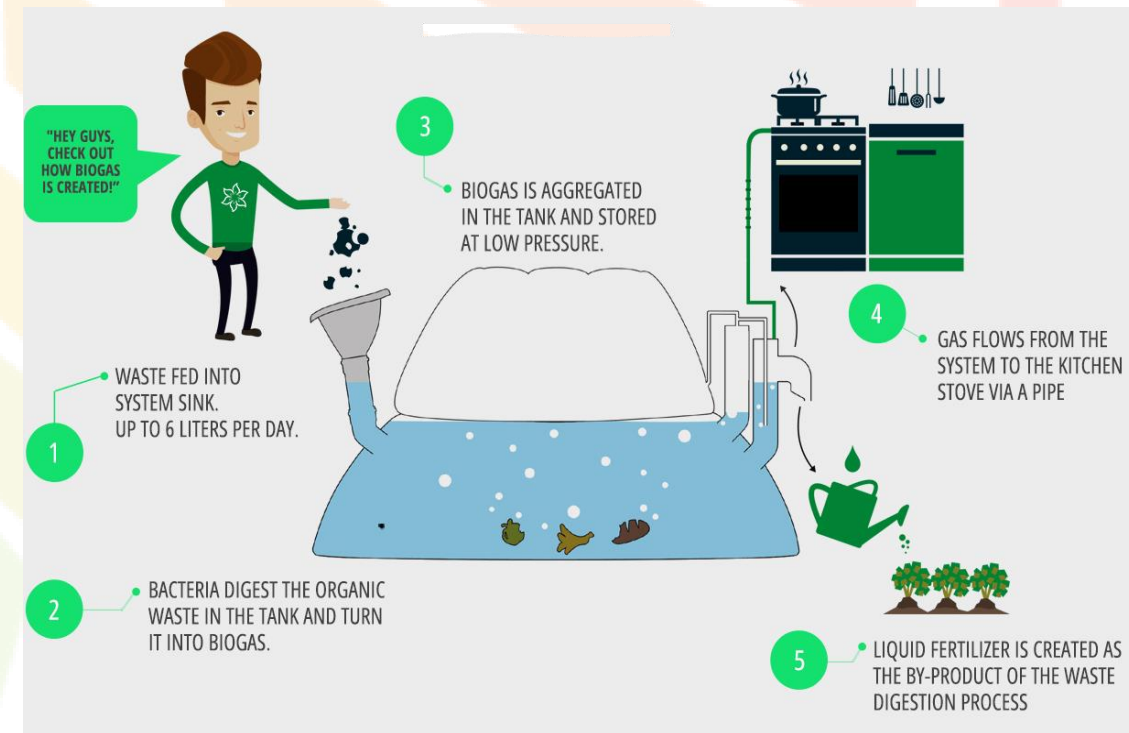

Bioenergy

Ministerio de INDUSTRIA Y COMERCIO | FUNDACIÓN MOISÉS BERTONI | Ministerio de AMBIENTE Y DESARROLLO SOSTENIBLE

## INICIATIVAS PARA LA PROMOCIÓN DE LA ECONOMÍA CIRCULAR EN PARAGUAY

Con el apoyo de los programas:

Country initiative



SDG 6



SDG 7



SDG 13



SDG 15



# Circular Economy Ecosystem: Recycling



Image courtesy of Cambridge Judge Business School



**2020-2022:** more than 85,600 kg of waste managed



SDG 6



SDG 7



SDG 13



SDG 15



# Circular Economy Ecosystem: Recycling

**DESAFÍO ITAIPU RECICLA 2022**



Incentivá al Reciclaje y **GANÁ**

Usar el Hashtag: **#ItaipuRecicla**

Participá sacándote una foto o video y subiéndola a alguna de tus redes sociales preferidas.

Podes mostrar acciones que motiven la reducción, reutilización o reciclaje.

Serán Premiadas las fotos o videos subidos entre el **17 al 20 de mayo** con más de 50 reacciones positivas 👍❤️👍👍 en tus redes sociales o vistos 👁️ en el estado del WhatsApp.

Dirigido a empleados, aprendices, pasantes y personal tercerizado de la ITAIPU Binacional.

Detalles a los Internos 8883 /7867/7866



Interactive Seminar "Towards a circular economy in the reuse and recycling of tires" - 130 participants

**ITAIPU RECICLA**

Exhibición de Artesanía del Reciclaje 2022



Del 20 al 29 de mayo, Centro de Recepción de Visitas de ITAIPU Binacional, ciudad de Hernandarias

De 08:00 a 16:00 hs

Detalles al: 061 599 8883



25 exhibiting artisans, more than 8,000 visitors

500 collaborators, around 10,000 views in social media.

# Circular Economy Ecosystem: Bioenergy

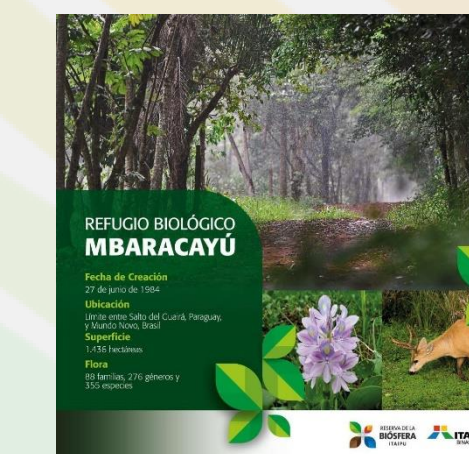
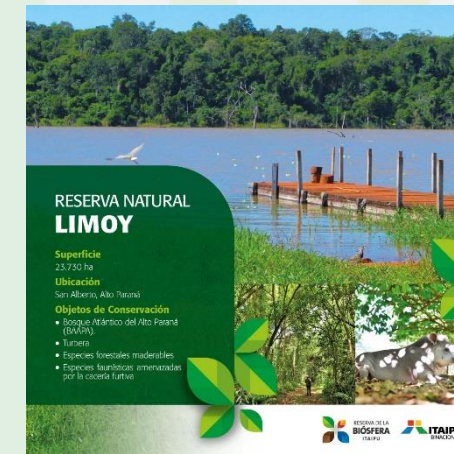
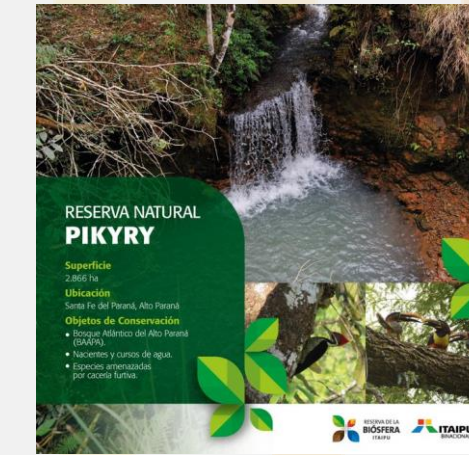
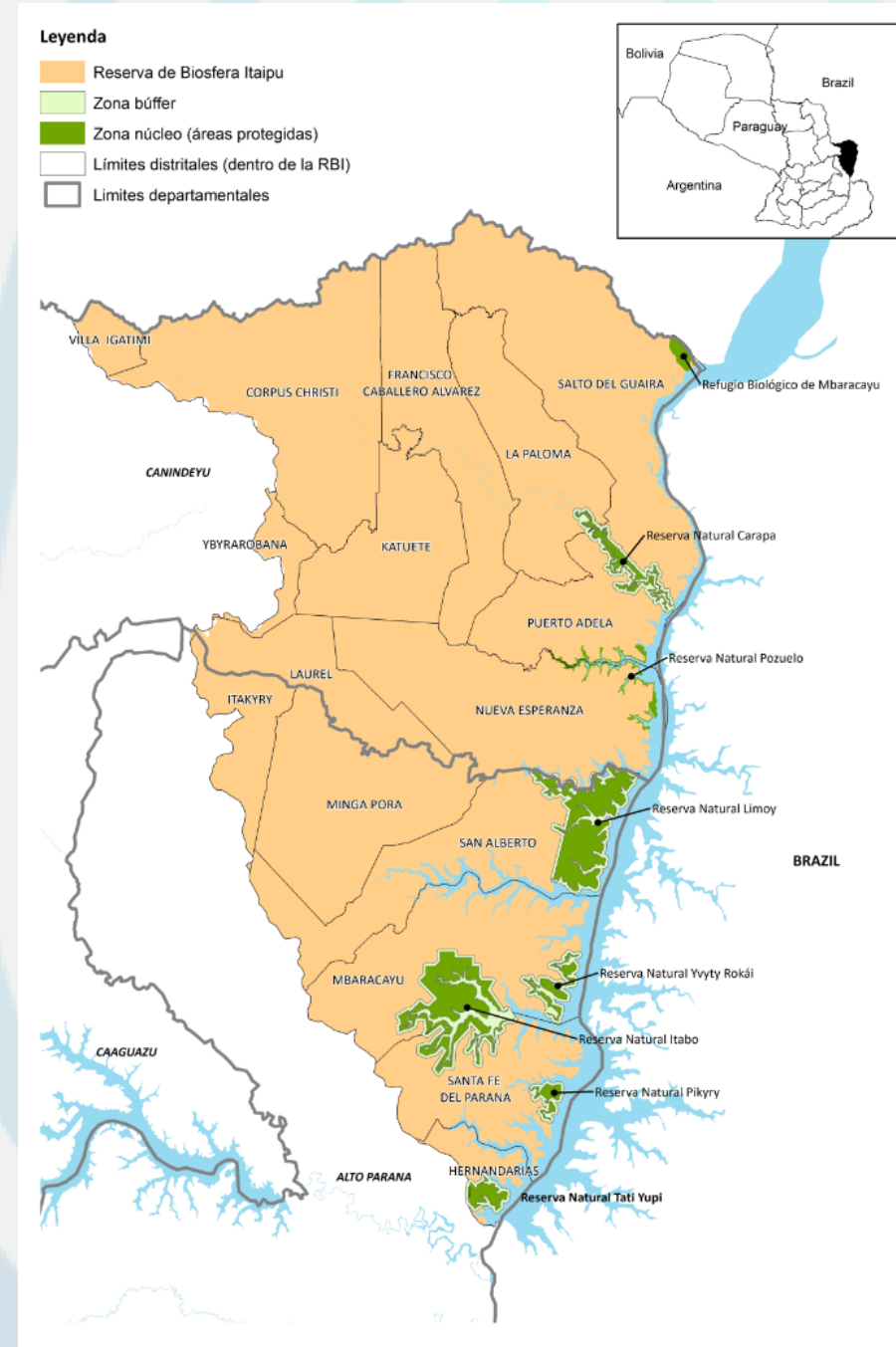
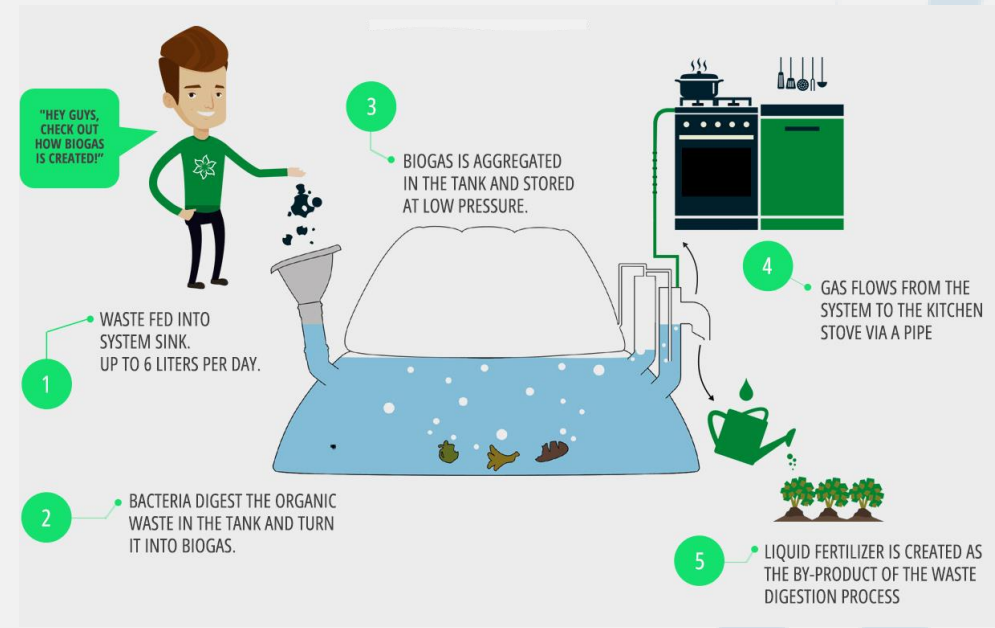

SDG 6



SDG 7



SDG 13



SDG 15



# Circular Economy Ecosystem: Bioenergy

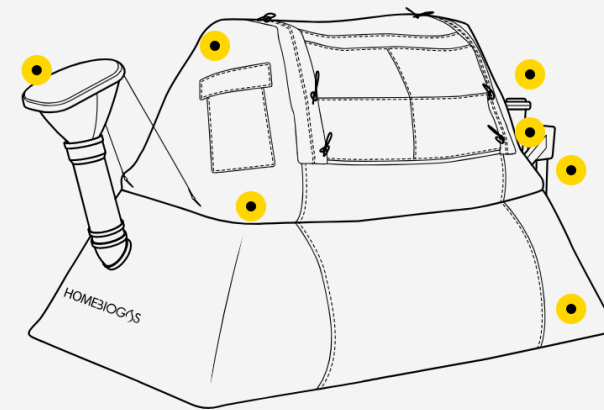

## TECH SPECS

**System dimensions**  
210x115x130 cm / 83x45x49 in

**Gas Tank volume**  
700 liters / 185gal

**Digester Tank volume**  
1200 liters / 317 gal

**Maximum daily quantity of kitchen waste**  
Up to 6 liters / 1.5 gal

**Maximum daily quantity of animal manure**  
45 liters / 12 gal of slurry:  
15 liters / 4 gal manure + 30 liters / 8 gal liters water

**Stove cooking time (single burner)**  
Up to 2 hours daily



SDG 6



SDG 7



SDG 13



SDG 15



# Circular Economy Ecosystem: Country initiative ([www.paraguaycircular.org.py](http://www.paraguaycircular.org.py))



## INITIATIVES FOR THE PROMOTION OF THE CIRCULAR ECONOMY IN PARAGUAY



With the support of the programs:



SDG 6



SDG 7



SDG 13



SDG 15



## 1) Promotion Group of the Circular Economy in Paraguay (GIEC)

## 1) Business support programs to promote circular models (Circular Opportunities Program, POC)





## 1) Promotion Group of the Circular Economy in Paraguay (GIEC)

➤ *Lead the transition of Paraguayan organizations towards a Circular Economy Model*

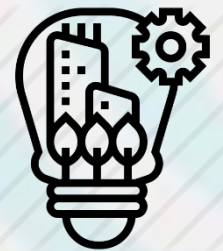

DEBATE ON CIRCULAR ECONOMY PLATFORM



ARTICULATION AND COORDINATION PLATFORM



ACTION PLATFORM



Linear economy



Circular economy



SDG 6



SDG 7



SDG 13



SDG 15



# Circular Economy Ecosystem: Country initiative ([www.paraguaycircular.org.py](http://www.paraguaycircular.org.py))

## 2) Circular Opportunities Program (POC)

➤ Give an initial impulse towards the generation of an innovative ecosystem about circular economy in Paraguay.

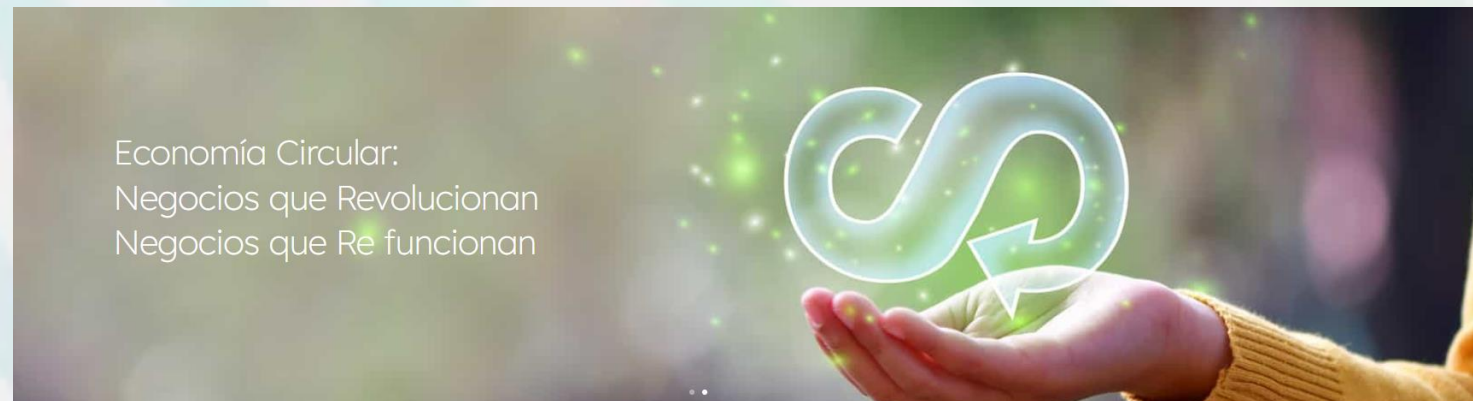

### // Sobre el Programa de Oportunidades Circulares

El Programa de Oportunidades Circulares (POC) es una convocatoria dirigida a mipymes industriales y asociativas rurales que buscan implementar proyectos de economía circular, ya sea creando una nueva línea de producción y/o diseñando un nuevo producto o servicio.

### ¿Qué es la Economía Circular?

Se trata de la nueva filosofía que promueve la producción de bienes y servicios de manera sostenible, reduciendo el consumo, el tiempo, las fuentes de energía y los desperdicios.

Propone un modelo donde los productos, procesos y servicios se diseñan especialmente para optimizar los recursos utilizados y minimizar la generación de residuos.

ECONOMÍA LINEAL

ECONOMÍA DEL RECICLAJE

ECONOMÍA CIRCULAR

Elaboración: <http://oportunidadescirculares.org/>

### // Socios implementadores

### // Sectores elegibles

La convocatoria está dirigida a dos sectores principales:

#### Asociativa rural

Asociativas rurales con al menos 2 años de actividad económica agrícola o agroindustrial, beneficiarias del programa MiPYME COMPITE.

[Postular](#)

#### Mipyme industrial

Mipymes industriales con al menos 1 año de actividad económica. Pueden ser o no beneficiarias actuales del Programa MiPYME COMPITE.

[Postular](#)



# Circular Economy Ecosystem: Country initiative ([www.paraguaycircular.org.py](http://www.paraguaycircular.org.py))

## Prioritized value chains



Fruit and vegetables



Herbs and yerba mate



Grains



Leather and its articles



Flours and baked goods



Partners:



Construction



Containers and packaging



SDG 6



SDG 7



SDG 13



SDG 15



# Circular Economy Ecosystem: Country initiative ([www.paraguaycircular.org.py](http://www.paraguaycircular.org.py))



Projects must promote at least one of the three principles of the circular economy:

- Eliminate waste and contamination from the design
- Keep products and materials in use
- Regenerate natural systems

## Awarded 2022

### UIP

**Marusa S.A.**  
Central

**EV-MOBILITY S.A**  
Central

**Bemor Calzados**  
Central

**Harina de Maiz 4 Colonias**  
Itapúa

**DASAMA**  
Asunción

### FECOPROD

**Cooperativa Yegros Ltda.**  
Caazapá

**La Esperanza**  
Misiones

**Cooperativa Piscicola**  
Paraguari

**Comité Santa Librada**  
Caaguazú

**Asociación de Citricultores**  
Cordillera

**Cooperativa Citricoop Ltda**  
Itapúa

### Fundación Moises Bertoni

**Madre S.A.**  
Asunción

**Ecocur**  
Villa Hayes

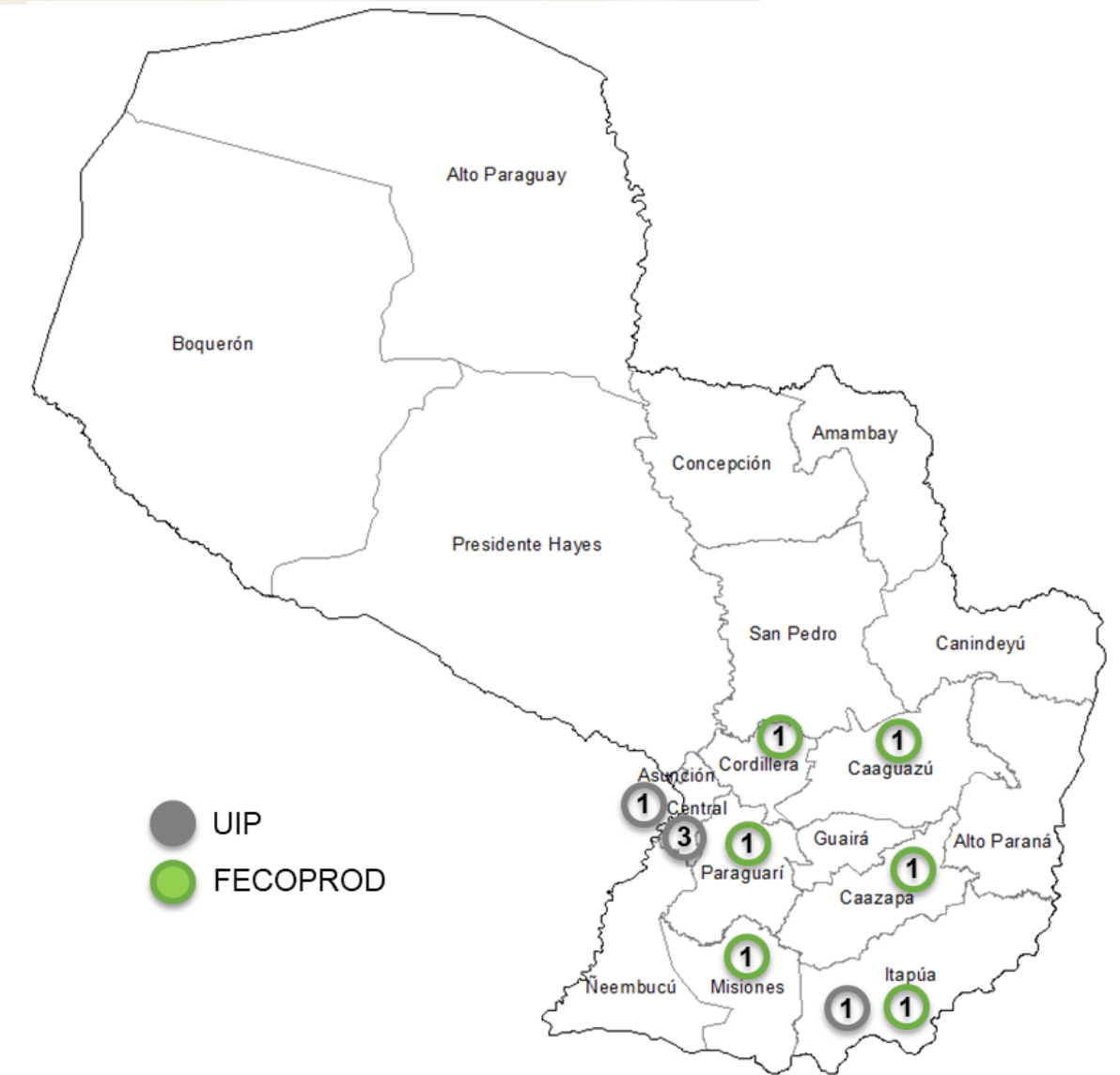

SDG 6



SDG 7



SDG 13



SDG 15



THANK YOU



Ana Carolina Gossen Siani

[gossen@itaipu.gov.py](mailto:gossen@itaipu.gov.py)

+ 595 982 797 422

